

**Abbildung 1-1: Verteiltes System**

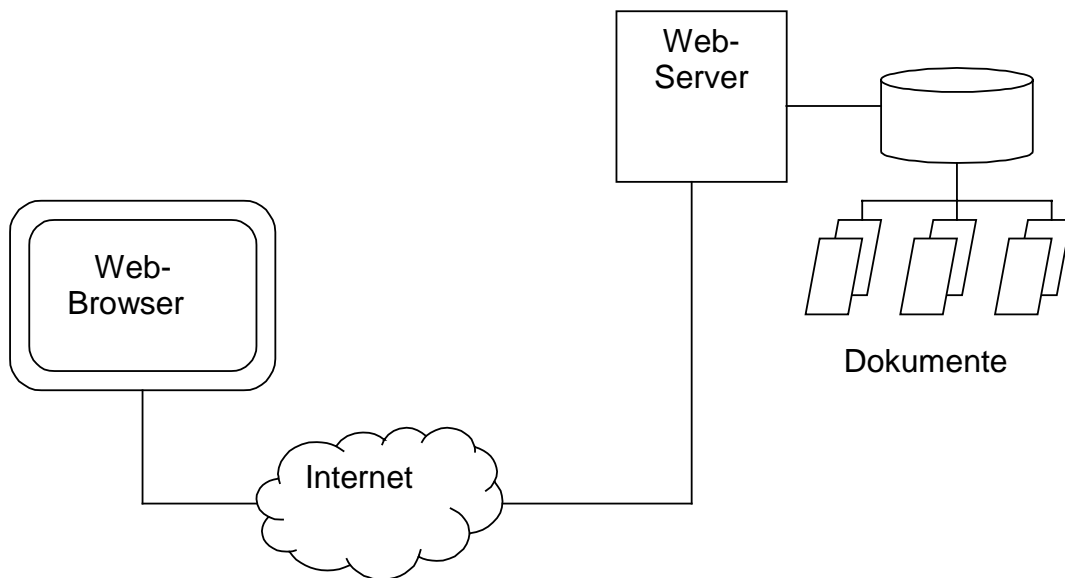

**Abbildung 1-2: Web-Informations-Systeme**



Abbildung 1-3: Funktion des Shell-Interpreter



Abbildung 1-4: Zwei Verteilungsstufen (two tier model)

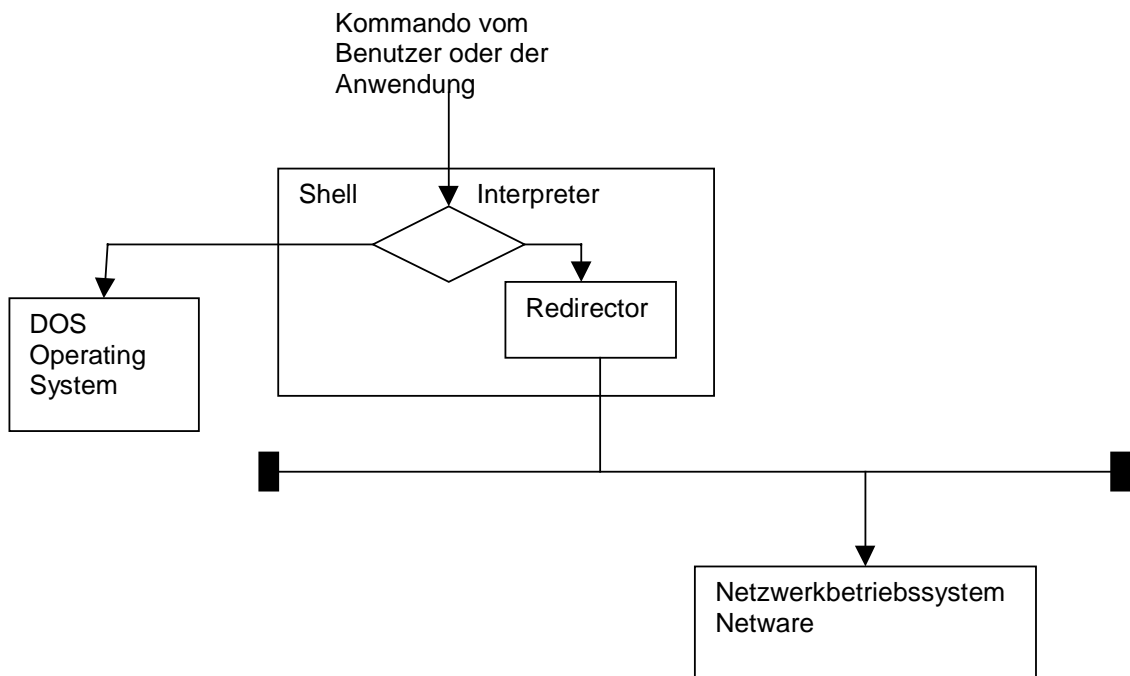

Abbildung 1-5: Dreischichtige verteilte Anwendung

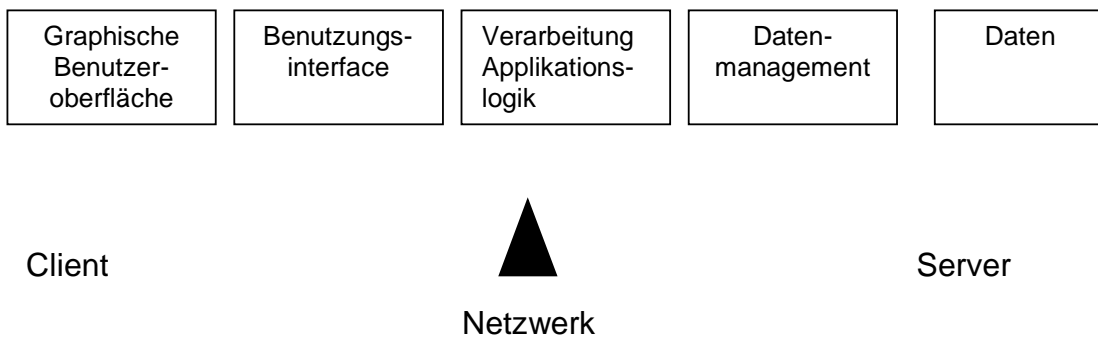

**Abbildung 1-6: Vierschichtige Web-Anwendung**

Programmierart:

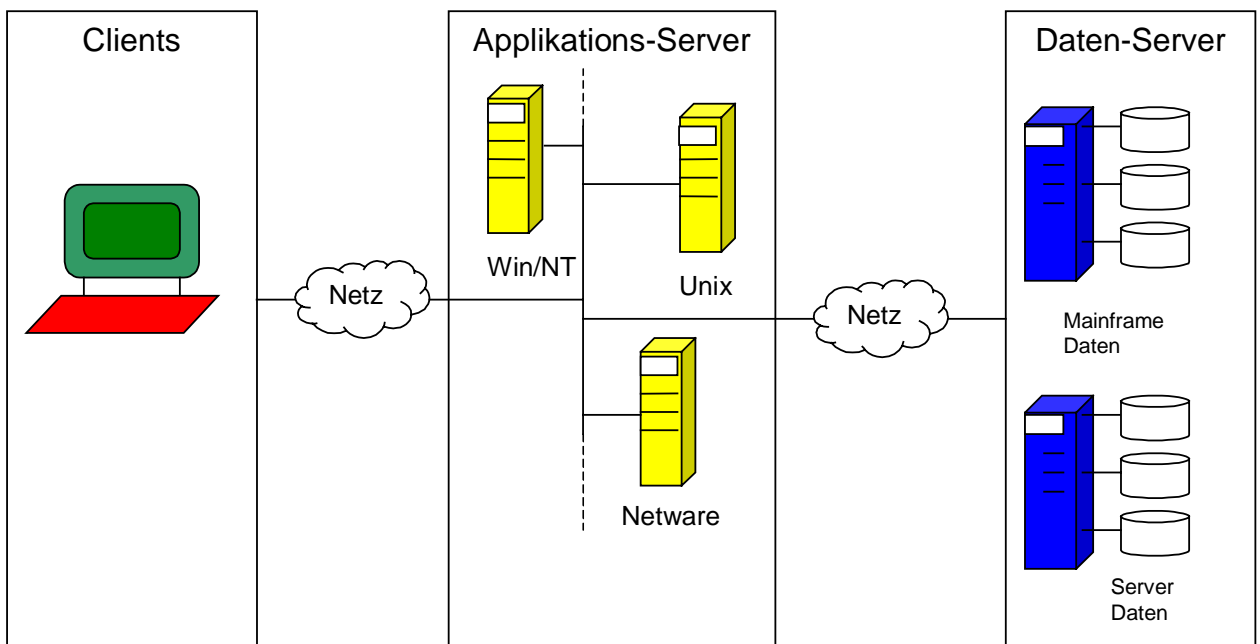
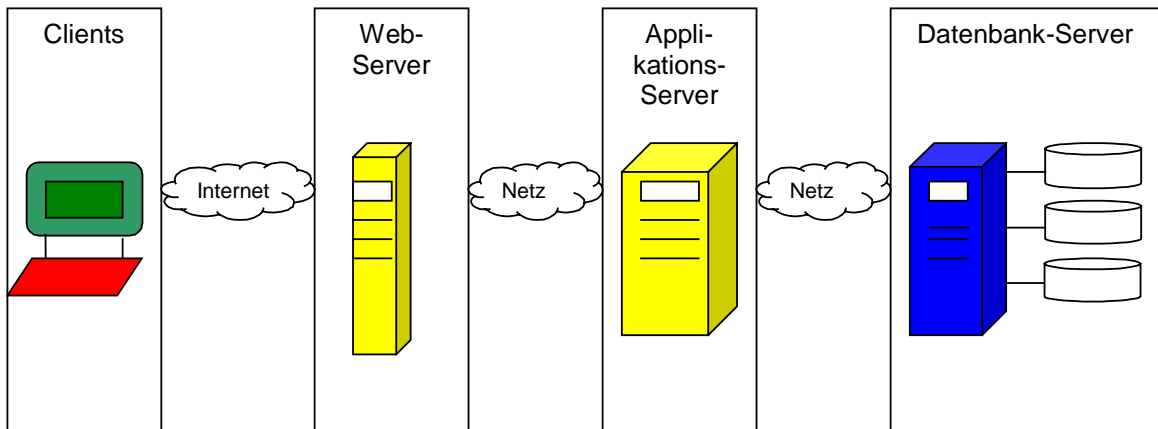
Systemschichten:

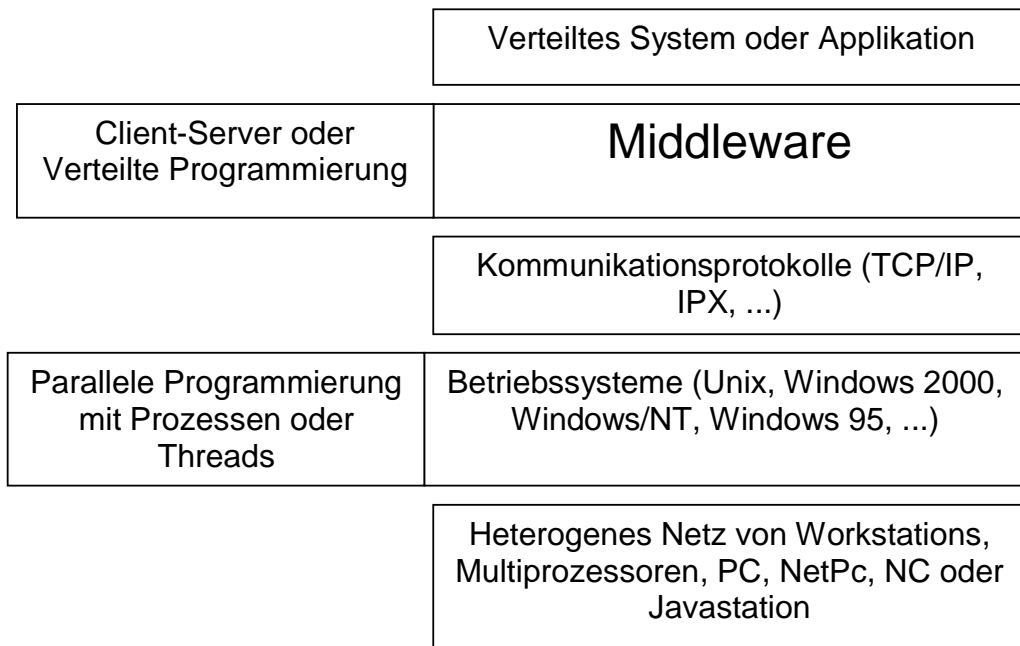

**Abbildung 1-7: Middleware**

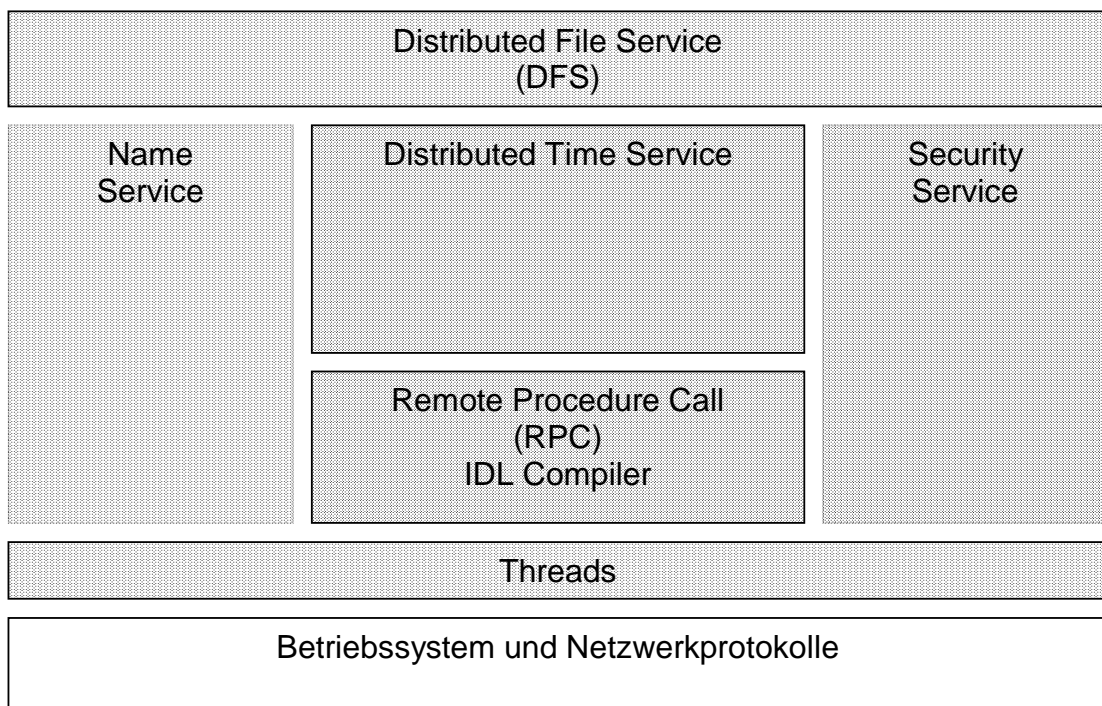

Abbildung 1-8: DCE-Komponenten